

A Accessories

Common Accessories

■ Contact Blocks and LED Blocks for Ø16 Control Switches



○ Ordering Information

SA	16	CB	W		
Item	Applied switches	Type	LED color ^{※1}	LED block	
				R	Red
				B	Blue
				G	Green
				Y	Yellow
	W	White			
	CB^{※2}	Contact block	B contact (normally closed)		
	CC	Contact block	C contact (normally open, normally closed)		
	L5	LED block	5VDC		
	L12		12VDC		
L24	24VDC				
16	For Ø16 control switches				
SA	Switch Accessories				

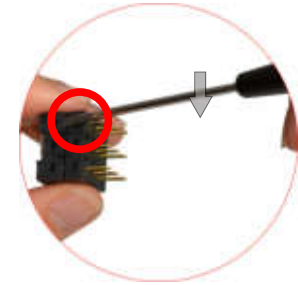
- **Contact block and LED block removal**
Separate the unit using a flat-head (-) screwdriver.



- ※1. Only for LED blocks.
※2. Only for Ø16 emergency switches.

Item	Appearance	Model	Type	Features
Contact block		SA16-CB	B contact (normally closed)	For Ø16 emergency switches
		SA16-CC	C contact (normally open, normally closed)	—
LED block		SA16-L5□ (5VDC) SA16-L12□ (12VDC) SA16-L24□ (24VDC)	DC voltage type	Diverse, vibrant, high luminance LEDs (red, blue, green, yellow, white)

■ Contact Blocks and LED Blocks for Ø22/25, Ø30, □30 Control Switches

○ Ordering Information

SA	-	CA	M																	
				Item																
				Applied switches																
				Type																
				LED color ^{※1}																
				Contact block type																
				<table border="1" style="width: 100%; border-collapse: collapse;"> <tr> <td style="width: 20%;"></td> <td style="width: 20%;">No-mark</td> <td>Singular type</td> </tr> <tr> <td></td> <td>M</td> <td>Modular type</td> </tr> </table>		No-mark	Singular type		M	Modular type										
	No-mark	Singular type																		
	M	Modular type																		
				<table border="1" style="width: 100%; border-collapse: collapse;"> <tr> <td style="width: 20%;"></td> <td style="width: 20%;">No-mark</td> <td>White</td> </tr> <tr> <td></td> <td>R</td> <td>Red</td> </tr> <tr> <td></td> <td>B</td> <td>Blue</td> </tr> <tr> <td></td> <td>G</td> <td>Green</td> </tr> <tr> <td></td> <td>Y</td> <td>Yellow</td> </tr> </table>		No-mark	White		R	Red		B	Blue		G	Green		Y	Yellow	
	No-mark	White																		
	R	Red																		
	B	Blue																		
	G	Green																		
	Y	Yellow																		
				<table border="1" style="width: 100%; border-collapse: collapse;"> <tr> <td style="width: 20%;"></td> <td style="width: 20%;">CA</td> <td>Contact block</td> <td>A contact (normally open)</td> </tr> <tr> <td></td> <td>CB</td> <td></td> <td>B contact (normally closed)</td> </tr> <tr> <td></td> <td>LD</td> <td>LED block</td> <td>AC/DC voltage: 12-24VAC 50/60Hz 12-24VDC</td> </tr> <tr> <td></td> <td>LA</td> <td></td> <td>AC voltage: 110-240VAC 50/60Hz</td> </tr> </table>		CA	Contact block	A contact (normally open)		CB		B contact (normally closed)		LD	LED block	AC/DC voltage: 12-24VAC 50/60Hz 12-24VDC		LA		AC voltage: 110-240VAC 50/60Hz
	CA	Contact block	A contact (normally open)																	
	CB		B contact (normally closed)																	
	LD	LED block	AC/DC voltage: 12-24VAC 50/60Hz 12-24VDC																	
	LA		AC voltage: 110-240VAC 50/60Hz																	
				<table border="1" style="width: 100%; border-collapse: collapse;"> <tr> <td style="width: 20%;"></td> <td style="width: 20%;">No-mark</td> <td>For Ø22/25, Ø30, □30 control switches</td> </tr> <tr> <td></td> <td>SA</td> <td>Switch Accessories</td> </tr> </table>		No-mark	For Ø22/25, Ø30, □30 control switches		SA	Switch Accessories										
	No-mark	For Ø22/25, Ø30, □30 control switches																		
	SA	Switch Accessories																		

• **Contact block and LED block removal**
Separate the unit using a flat-head (-) screwdriver.



※1. Only for LED blocks.

※Multi-unit connection is only available for modular type (SA-□M).

Item	Appearance	Model	Type	Features
Modular type contact block		SA-CAM	A contact (normally open)	Ring or spade terminals / Multi-connection (up to 3 units)
		SA-CBM	B contact (normally closed)	
Singular type contact block		SA-CA	A contact (normally open)	Spade terminals only / Loose screw prevention
		SA-CB	B contact (normally closed)	
Modular type LED block		SA-LD□M	AC/DC voltage type 12-24VAC 50/60Hz 12-24VDC	Diverse, vibrant, high luminance LEDs (Red, Blue, Green, Yellow, White)
		SA-LA□M	AC voltage type 110-220VAC 50/60Hz	
Singular type LED block		SA-LD□	AC/DC voltage type 12-24VAC 50/60Hz 12-24VDC	
		SA-LA□	AC voltage type 110-220VAC 50/60Hz	

Control Switches

- Ø16
- Ø22/25
- Ø30
- 30

Push Button Switches

- Round
- Square
- Rectangular

Selector Switches

- Round
- Square
- Rectangular

Key Selector Switches

- Round
- Square
- Rectangular

Double Push Button Switches

Mushroom-head Push Button Switches

Emergency Switches

Pilot Lights

Accessories

Buzzers

A Accessories

Switch Enclosures for Ø22/25 Control Switches

Ordering Information

SA	—	SB	3	
Item	Applied switches	Appearance	Holes	
			1	1 hole
			2	2 holes
			3	3 holes
			4	4 holes
Item	Applied switches	Appearance	SB	Square type
			TB	Triangle type
Item	Applied switches	Appearance	No-mark	For Ø22/25 control switches
			SA	Switch accessories



※You can order the other size and the number of holes.

• Hole size: Ø22.5/25.5mm

(unit: mm)

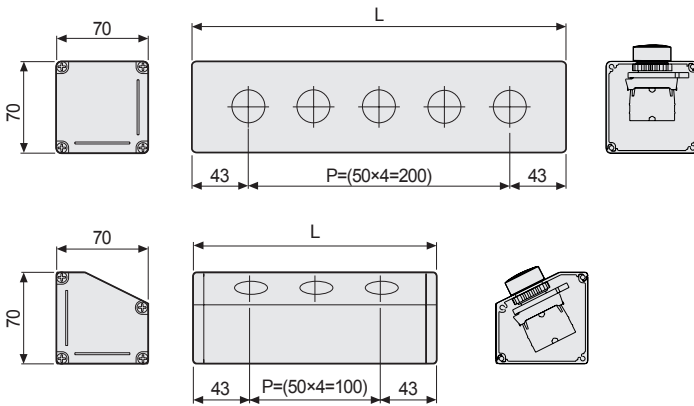

Holes	L
1	86mm
2	136mm
3	186mm
4	236mm
5	286mm













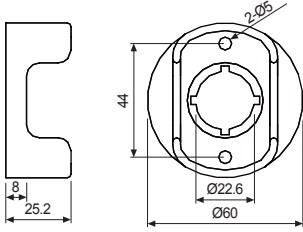

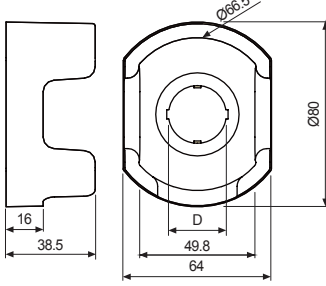
Locking Handle for Switches

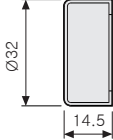
Applied switches	Appearance	Model	Note
Ø16		SA16-LH	For locking switch nuts behind the panels
Ø22/25, Ø30 ^{※1} , □30		SA-LH	

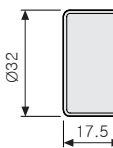
※1. Except Ø30 round pressure switches (extended).

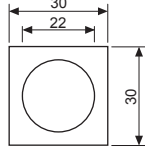
Accessories By Item

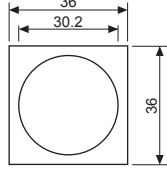
(unit: mm)

Item	Appearance	Model	Dimensions	Note						
Emergency switch nameplates		SA-NS	Size: D60×d25	Standard and illuminated nameplates are available for emergency switches. ※Illuminated nameplates are optional. ※D60 emergency switches (S2ER-E5R□) are not compatible with SA-NS nameplates						
		SA-NL	Size: D80×d25							
Protective shrouds for emergency switches		SA-EG1		Protective shrouds to prevent accidental/incorrect operation <table border="1" style="margin-top: 10px;"><thead><tr><th colspan="2">D</th></tr></thead><tbody><tr><td>SA-EG2</td><td>Ø22.5</td></tr><tr><td>SA-EG3</td><td>Ø25.5</td></tr></tbody></table> ※Not available for D60 emergency switches (S2ER-E5R□).	D		SA-EG2	Ø22.5	SA-EG3	Ø25.5
	D									
SA-EG2	Ø22.5									
SA-EG3	Ø25.5									
	SA-EG2/ SA-EG3									
Waterproof cap for Ø22/25 round push button switches		SA-WP (non-illuminated/ extended)		IP65 protection structure with waterproof cap						
	 (extended)	SA-WL (illuminated/ extended)								
Ø20/25 Switch washer		SA-SW2		The washer helps to improve switch tightening force.						
Ø30 Switch washer		SA-SW3								
Lens remover for Ø16 push button control switches or pilot lights		SA16-RM		Lens remover for push button control switches or pilot lights						

Control Switches

Ø16

Ø22/25

Ø30

□30

Push Button Switches

Round

Square

Rectangular

Selector Switches

Round

Square

Rectangular

Key Selector Switches

Round

Square

Rectangular

Double Push Button Switches

Mushroom-head Push Button Switches

Emergency Switches

Pilot Lights

Accessories

B buzzers